



# **NEW, COMFORTABLE, POWERFUL CONTROL WELLDRIVE**

WD770; A next generation variable frequency drives that provides an excellent solution for all your HVAC, Water, and Compressor applications.

**Honeywell**



# CONTENTS

Page	Title
3	About Honeywell
4 - 5	About WellDrive
6 - 7	General Applications
8 - 9	Hardware Features
10 - 11	Software Features
12 - 13	General Features
14	Ratings
15	Service and Support



## About Honeywell

Honeywell ([www.honeywell.com](http://www.honeywell.com)) is a Fortune 100 technology company that delivers industry specific solutions that include aerospace products and services; control technologies for buildings and industry; and performance materials globally. Honeywell technologies help everything from aircraft, buildings, manufacturing plants, supply chains, and workers become more connected to make our world smarter, safer, and more sustainable.

Honeywell, which automates indoor comfort in Building Management Systems, utilizes its more than 100 years of experience and high technology to maximize energy efficiency. Honeywell holds a global leadership position by having implemented this comfort in over 10 million buildings.



# WELLDRIIVE WD770

## ALL YOUR NEEDS IN ONE PRODUCT

The WD770 series of Honeywell WellDrive VFDs are a new generation drives designed for all HVAC and Pump applications, providing increased system efficiency, energy savings and reduced costs.

Designed for all Air Conditioning, Ventilation, Heating, Cooling, Water and Waste Water applications, the WD770 series drives are fully compatible with all AC motor types.

WD770 drives, offered to you under Honeywell brand and extensive industry experience, provide you ease of use and flexibility with powerful hardware and software features.





## TOTAL COST

Considering all the operating and maintenance costs over its lifetime, the WellDrive WD770 meets all your expectations to minimize your costs with its quality and features.

## ENERGY EFFICIENCY

It increases energy savings in your systems thanks to its special software in all applications where energy savings are achieved more. You will also save money thanks to its compatibility with high efficiency motors.

## COMFORT AND SAFETY

Thanks to its robust construction, the WD770 provides high comfort and safety in harsh environmental conditions for all HVAC and Water applications.

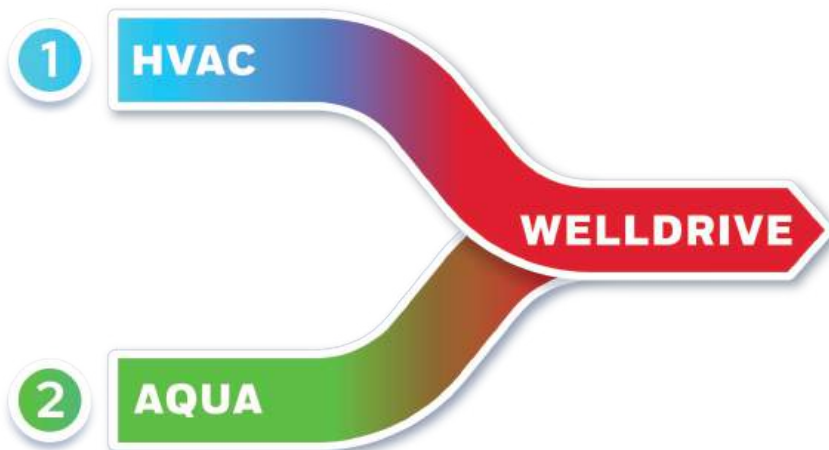

# GENERAL APPLICATIONS

## HVAC & WATER



Air Handling Units



Chillers



Air Compressors



Tunnel Fans



Refrigeration



Mining Fans

Critical requirements provided as standard with WellDrive in HVAC applications:

- Fire Mode
- Compressor Torque
- PID Control
- PID Auto-Tuning
- Sleep Mode
- Real Time Clock
- Flying Start
- Power Loss Ride-Through
- Bypass
- Regeneration
- Energy Saving
- Motor Pre-heating
- Freeze Protection
- Communication Options
- HVAC Protections

**Critical requirements provided as standard with WellDrive in Water and Wastewater applications:**

- Cascade Control (8 Pumps)
- Water Hammer Prevention
- Dry Run Prevention
- Pump Cleaning
- Pipe Filling
- Real Time Clock
- Flying Start
- PID Control
- PID Auto-Tuning
- Sleep Mode
- Energy Saving
- Power Loss Ride-Through
- Fire Mode
- Communication Options
- AQUA Protections



Centrifugal Pumps



Hydrophore Systems



Cooling Towers



Heating Systems



Decanters



Greenhouse

# ULTIMATE PERFORMANCE POWERFUL HARDWARE



## Harmonic Filters (DC Choke)

Built-in DC chokes reduce harmonic distortion in the grid in accordance with IEC 61000-3-12 standards. They also increase the lifetime of the DC link capacitors and therefore the efficiency of the drive.



## Coated PCBs

All electronic components within WellDrive are protected by varnish coating in accordance with IEC 60721-3-3 standards.



## EMC Filters

WellDrive WD770 products have built-in EMC/RFI filters as standard. You can specify the standard or optional EMC filter type in accordance with the following standards.

EMC STANDARDS	CATEGORIES		
EN/IEC 61800-3 (for VFD manufacturers)	Category C1 1.Env. / Home-Office	Category C2 1.Env. / Home-Office	Category C3 1.Env. / Industrial
WellDrive Compatibility	✓	✓	✓
EN 55011 (for Facilities)	Class B Residential Area	Class A (Group 1) Industrial Area	Class A (Group 2) Industrial Area
WellDrive Compatibility	✓	✓	✓



## Advanced User Friendly Keypad

WellDrive offers great convenience in your commissioning processes with its easy-to-carry Graphic LCD Display Operator Panel, which includes multiple language options, a 5-line wide screen, Real-time clock, and many other features.

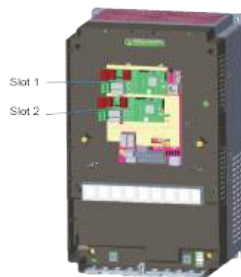

## Expansion Modules

The WD770 can be expanded with optional I/O and various communication cards. This provides flexible compatibility for your system.

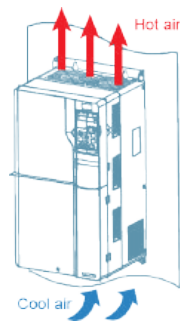

## Independent Cooling

WellDrive's independent air duct design prevents dust from entering electronic components, extending their life and reducing service costs.

## Voltage Protection

Protect the system against short-term voltage fluctuations in the grid and ensures the continuity of the system.

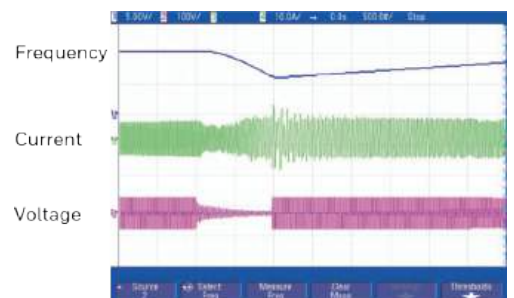

# ADVANCED FEATURES

## FLEXIBLE SOFTWARE



### Fire Mode

In the event of a fire, it prevents the drive from ignoring all warning and error signals and taking itself into self-protection, thus ensuring continuous operation of the fan or pump.

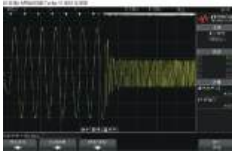

### Flying Start

It monitors the rotational speed of the motor to reduce the incoming pulse and improve restart efficiency, and ensures that the motor resumes at the same speed at restart.

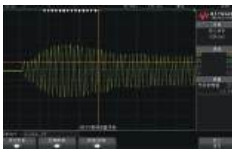

### Power Loss Ride-Through

In the event of a momentary power failure, the drive will continue to run automatically if this function and the start signal are active.

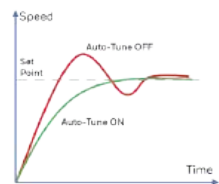

### PID Control

It provides precise control of your process values such as Temperature, Pressure, Flow, Humidity without the need for an external controller. It also provides lower and upper limit level control. It reaches stable operation quickly and easily thanks to its Auto-Tune feature.

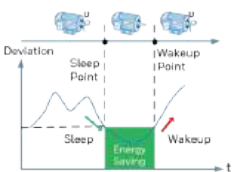

### Sleep & Wakeup

It ensures that the motor stops when there is no demand and saves energy. When the demand increases and the set values are reached, the motor is automatically restarted.

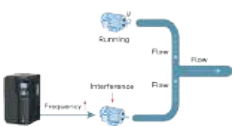

### Regeneration Mode

One of the fans sharing the same flow duct is in a regeneration state under the influence of the others. The drive automatically keeps the output frequency under control to prevent over-voltage alarm and ensure stable operation of the machine.



### ECO Mode

Optimizes output power, ensuring optimum performance and lowest losses for low dynamic loads.



### WellSoft

It is free software with a user-friendly interface that allows you to easily program the WellDrive product family from your computer and access many of its functions.



### Advanced Cascade Control

Up to 8 pumps can control multiple pumps. Real time clock support, synchronization and roaming master features are available.

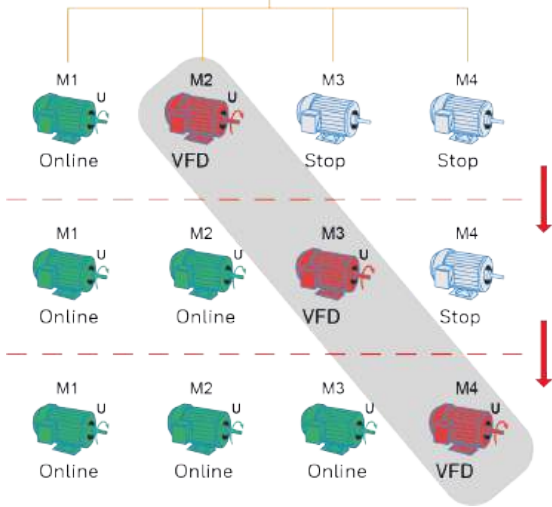

### ByPass Function

It allows a motor to be started from the mains when the failed drive cannot be used or when it is necessary to continue running at full speed.



### Pump Cleaning

It detects blockages that may occur in the pumps and ensures cleaning by systematically running forward and backward. This not only saves on mechanical maintenance but also keeps the pump's efficiency at its highest level.

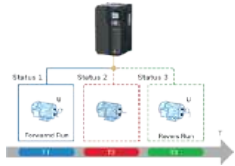

### Dry Run Protection

By continuously monitoring the pump operation, it detects dry running or leakage and prevents mechanical damage to the pump.



### Pump Filling Mode

In applications where controlled pipe filling is required, a slow and gentle operation at the start-up or stop of the pumps prevents ramming and damage to pipes or heads.



### Real Time Clock (RTC)

When used with the LCD Panel, the driver can be programmed according to the time and date information, and malfunctions can be monitored.



### Motor Pre-Heating

The driver provides DC current during power interruptions to increase the motor's surface temperature and prevent motor failure caused by condensed water.



### Freeze Protection

When the ambient temperature drops below a set threshold, the motor starts automatically to prevent the water from freezing and thus protect the pump.

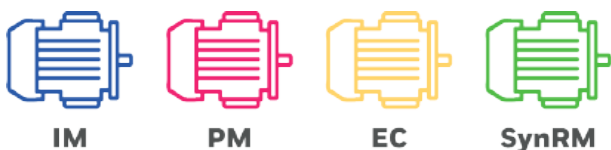

### Advanced Motor Control

The WD770 can control standard induction motors (IM), permanent magnet motors (PM), asynchronous and synchronous reluctance motors (SynRM) with high efficiency.

# WELLDRIIVE WD770

## GENERAL FEATURES

	FUNCTIONS	FEATURES
Control	Input Voltage	3 Phase 380 - 480 Vac
	Voltage Tolerance	-15% to +10%
	Input Frequency	50 Hz or 60 Hz. (Max 47 - 63 Hz.)
	Control Mode	Advanced Scaler Control, Sensorless Vector Control
	Motor Type	IM, PM, SM, SYNRM
	Speed Ratio	Asynchronous Motor: 1:200, PM and Synchronous Motor: 1:20
	Speed Control Accuracy	±0.2% (Vector Control)
	Speed Fluctuation	±0.3% (Vector Control)
	Torque Response	<20ms (Vector Control)
	Torque Control Accuracy	±10% (Vector Control)
	Switching Frequency	1 - 15 kHz (Standard 4 kHz)
	Overload Capability	110% of rated current for 1 minute every 5 minutes.
Operation	Frequency Settings	Analog, Digital inputs, Pulse input, Constant Speeds, Built-in PLC, PID Control, Communications
	Operating Frequency	0 - 400 Hz.
	Ramp Time	0 - 3600 sn.
	Voltage Regulations	Automatically regulates the output voltage in response to mains fluctuations.
	Fault Protections	Overcurrent, Overvoltage, Undervoltage, Short Circuit, Overload, Overheat, Phase Loss etc.
	Special Features	Fire Mode, Cascade Control (8 pumps), PID with Sleep Mode, ByPass, Pump Cleaning, Dry Run, Regeneration Mode, Power Loss Ride Through, Flying Start, DC-Link, Pre-Heating, Freeze Protection, Pipe Filling etc.
Interface	Flying Start	Used to implement shockless smooth starting for rotating motors.
	Analog Input	2x Analog Inputs 1x 0 (2)~10V / 0 (4)~20mA and 1x -10 ~ +10V
	Analog Output	2x Analog Outputs: 0 (2)~10V/0 (4)~20mA
	Digital Type	PNP or NPN selectable. 24 Vdc. Impedance 3.3kΩ
	Digital Input	5x Digital Inputs Max. 1kHz
	Digital Input	1x High Frequency Pulse Input Max. 50kHz
	Digital Output	1x Digital Output (Same features with the Relays)
	Relay Output	2x Programmable Relay Output (NO and NC) (3A/AC250V, 1A/DC30V)
	Keypads	Standard LED keypad, Optional removable LCD keypad (RJ45 - Cat6)
	Communications	Standard Modbus RTU (RS485), Optional Profibus, Profinet, BACnet, Modbus-TCP, CanOpen etc.
Other	Expansions	Two expansion slots. Expansion I/O cards, Communication options etc.
	Mounting Types	Wall Mounting (up to 250kW), Floor Mounting (up to 132kW), Flange Mounting (220kW~500kW)
	EMC Filter	Built-in class C3 according to EN/IEC 61800-3, optional class C2
	Harmonic Filter	Built-in DC choke according to IEC 61000-3-12 standard
	Operating Temperature	-10°C ~ +50°C
	IP Protection Class	IP20 for below 200 kW, IP00 for 200 kW and above.
	Coated PCBs	2nd degree according to IEC60721-3-3 standards
	Power Factor (Cos φ)	> 0.98
	Altitude	100% of rated current for ≤1000 m. 1% derating for every 100 meters between 1000 - 3000 m.
	Relative Humidity	5% - 95% (IEC 721-3-3; Class 3K3 (non-condensing) (during operation)
	Galvanic Insulation	Standard (PELV)
	Efficiency	0,98
Cooling Method	1.5kW: Natural cooling, 2.2kW and above: Fan cooling. Independent cooling channel	

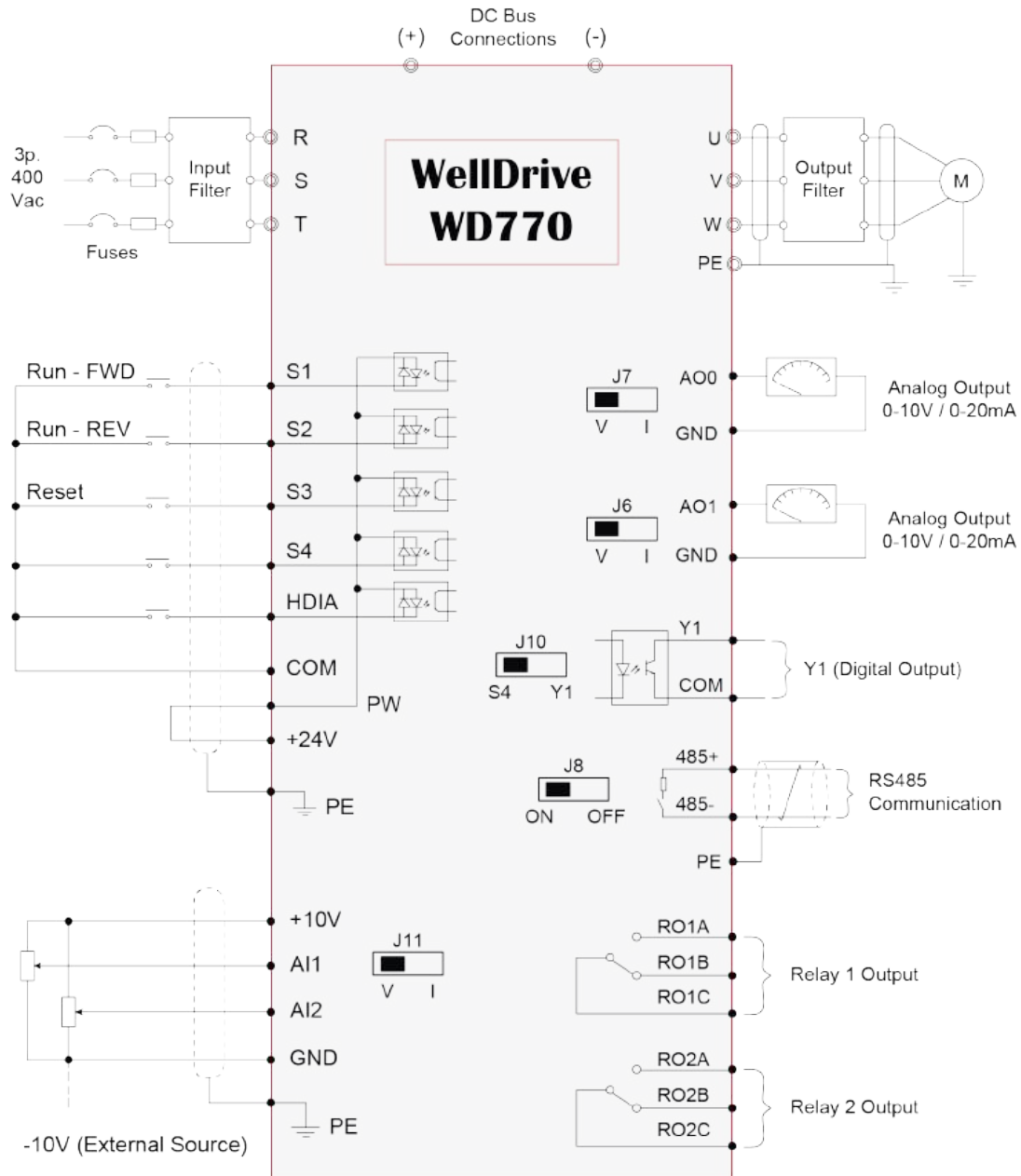

## OPTION MODULES

References	Descriptions
WDM-IO-1	IO Module (4xDI, 1xDO, 2xRO, 1xAI, 1xAO)
WDM-RO-1	Relay Module (6xRO, 2xDI)
WDM-BC-1	BACnet Communication Module
WDM-PB-1	ProfiBus-DP Communication Module
WDM-PN-1	ProfiNET Communication Module
WDM-MT-1	Modbus-TCP Communication Module
WDM-CO-1	CANopen (for Master-Slave applications)
WDM-24-1	External 24Vdc Power Supply Terminal
WDM-BOP-1	Basic Keypad
WDM-LCD-1	Advanced LCD Keypad
WDM-EXT-1	Keypad Mounting Kit
WDM-MRL-1	DIN Rail Mounting Kit



# WELLDRIIVE WD770

## RATINGS

RATINGS TABLE					
DRIVE POWER	PRODUCT REFERENCE	NOMINAL CURRENT	FRAME TYPE	DIMENSIONS W x H x D (mm.)	NET WEIGHT
0.75 kW	WD770-3A7-4	3.7 A	F1	89 x 231 x 193	2 Kg
1.5 kW	WD770-3A7-4	3.7 A			
2.2 kW	WD770-5A0-4	5.0 A			
3 kW	WD770-9A5-4	9.5 A			
4 kW	WD770-9A5-4	9.5 A			
5.5 kW	WD770-13A-4	13 A	F2	89 x 259 x 211.5	2.4 Kg
7.5 kW	WD770-17A-4	17 A			
11 kW	WD770-25A-4	25 A	F3	145 x 280 x 207	5 Kg
15 kW	WD770-32A-4	32 A			
18.5 kW	WD770-38A-4	38 A	F4	169 x 320 x 214	6.4 Kg
22 kW	WD770-45A-4	45 A			
30 kW	WD770-60A-4	60 A	F5	266 x 371 x 208	11 Kg
37 kW	WD770-75A-4	75 A			
45 kW	WD770-92A-4	92 A	F6	316 x 430 x 223	16 Kg
55 kW	WD770-115A-4	115 A	F7	352 x 580 x 258	24 Kg
75 kW	WD770-150A-4	150 A			
90 kW	WD770-180A-4	180 A			
110 kW	WD770-215A-4	215 A	F8	338 x 554 x 338.3	43 Kg
132 kW	WD770-250A-4	250 A			
160 kW	WD770-305A-4	305 A	F9	338 x 825 x 398.3	78 Kg
185 kW	WD770-330A-4	330 A			
200 kW	WD770-380A-4	380 A			
220 kW	WD770-425A-4	425 A	F10	303 x 1108 x 480	103 Kg
250 kW	WD770-460A-4	460 A			
280 kW	WD770-530A-4	530 A	F11	330 x 1288 x 544	121 Kg
315 kW	WD770-600A-4	600 A			
355 kW	WD770-650A-4	650 A			
400 kW	WD770-720A-4	720 A	F12	330 x 1398 x 544	173 Kg
450 kW	WD770-820A-4	820 A			
500 kW	WD770-860A-4	860 A			

- You may also contact our expert team for higher power and other voltage options.
- The WD770 has a loadability of 110% for 1 minute every 5 minutes over its rated current rating.

# SERVICE CENTERS EXTENSIVE SUPPORT

For WellDrive products, you can get service from a wide service network and expert support team. Please contact us for support.



**Note - 1:** The network map above shows only the points where service is available. We do not have sales service at these points.

**Note - 2:** Our sales services are only available in Turkey, Azerbaijan, Uzbekistan, Turkmenistan and Kazakhstan.





For full information about WellDrive, manuals, drawing files and other topics you can visit the website:

[www.HoneywellVFD.com.tr](http://www.HoneywellVFD.com.tr)

**Honeywell**